

Übersicht zweikanalige Not - Aus - Schaltungen
Two-Channel E-Stop Circuits Overview
Vue d'ensemble des circuits d'arrêt d'urgence à deux canaux

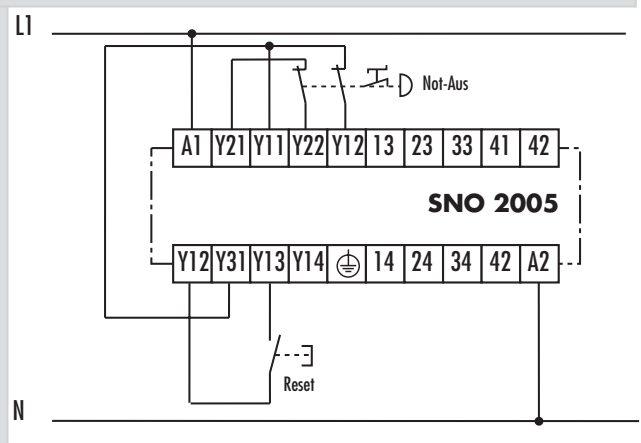

Übersicht zweikanalige Not - Aus - Schaltungen
Two-Channel E-Stop Circuits Overview
Vue d'ensemble des circuits d'arrêt d'urgence à deux canaux

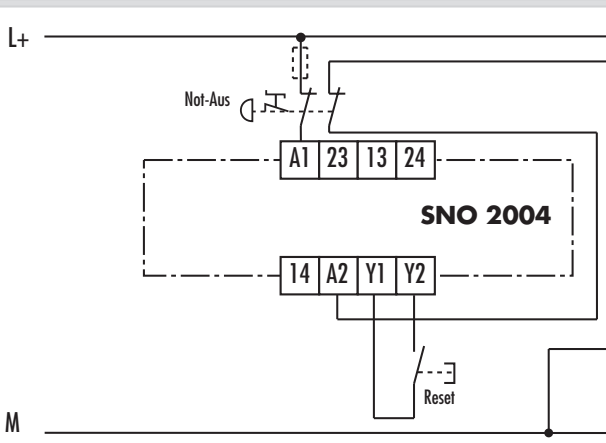
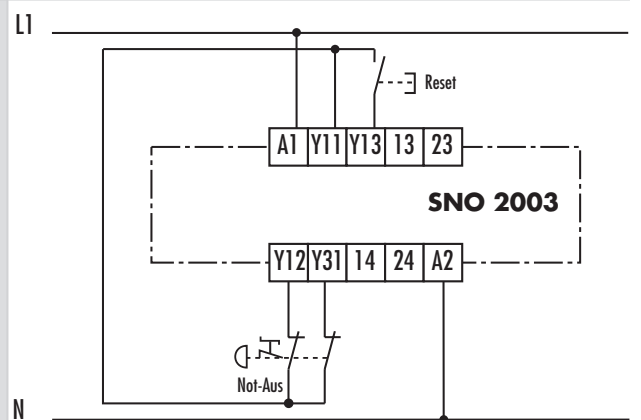
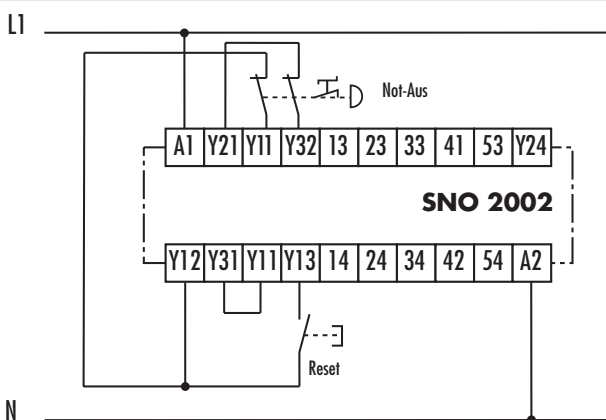
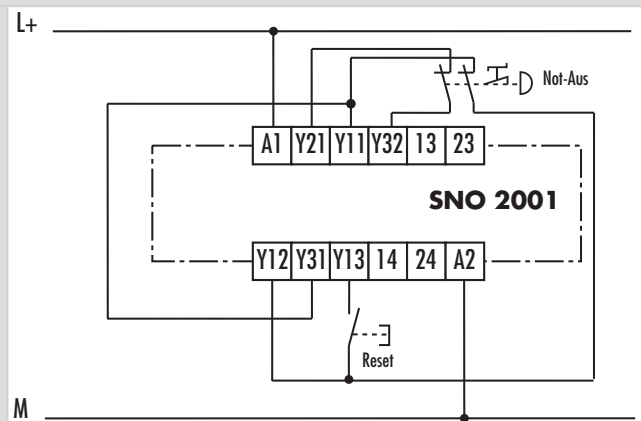
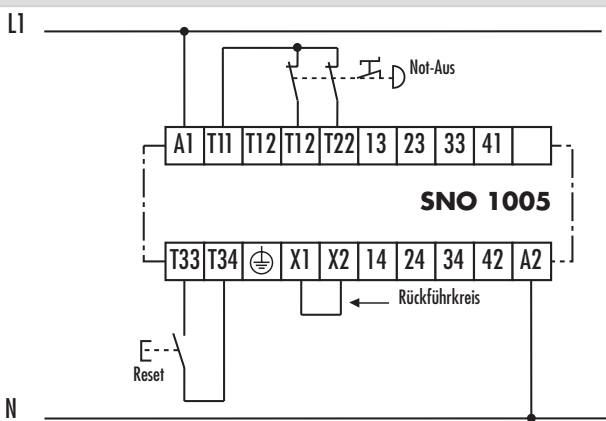
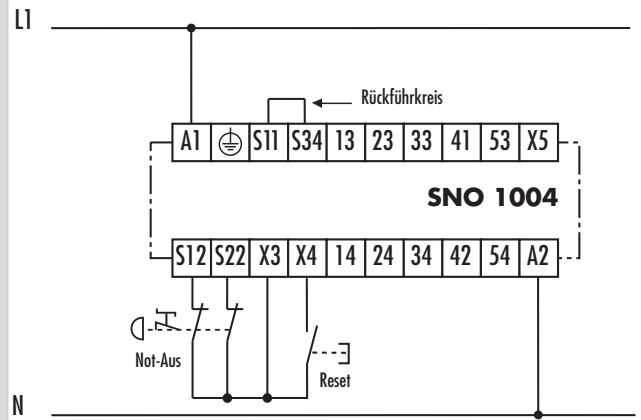
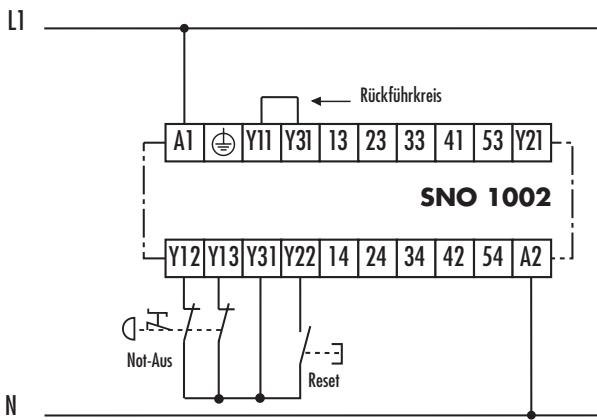